

Features

- N-Channel, 5V Logic Level Control
- Enhancement mode
- Very low on-resistance $R_{DS(on)}$ @ $V_{GS}=4.5V$
- Fast Switching
- Pb-free lead plating; RoHS compliant

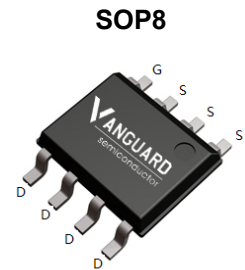

V_{DS}	60	V
$R_{DS(on),TYP}@ V_{GS}=10V$	9.5	m Ω
$R_{DS(on),TYP}@ V_{GS}=4.5V$	11.5	m Ω
I_D	13	A



Part ID	Package Type	Marking	Tape and reel information
VSO012N06MS	SOP8	012N06M	3000pcs/Reel

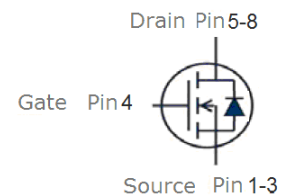

Maximum ratings, at $T_j=25^\circ\text{C}$, unless otherwise specified

Symbol	Parameter	Rating	Unit
$V_{(BR)DSS}$	Drain-Source breakdown voltage	60	V
I_S	Diode continuous forward current	$T_A=25^\circ\text{C}$ 13	A
I_D	Continuous drain current @ $V_{GS}=10V$	$T_A=25^\circ\text{C}$ 13	A
		$T_A=100^\circ\text{C}$ 8.3	A
I_{DM}	Pulse drain current tested ①	$T_A=25^\circ\text{C}$ 42	A
IAS	Avalanche Current max	55	A
P_D	Maximum power dissipation	$T_A=25^\circ\text{C}$ 3	W
V_{GS}	Gate-Source voltage	± 20	V
$T_{STG} T_J$	Storage and operating temperature range	-55 to 150	$^\circ\text{C}$

Thermal Characteristics

Symbol	Parameter	Typical	Unit
$R_{\theta JC}$	Thermal Resistance-Junction to Case	24	$^\circ\text{C/W}$
$R_{\theta JA}$	Thermal Resistance Junction-Ambient	40	$^\circ\text{C/W}$

Typical Characteristics

Symbol	Parameter	Condition	Min.	Typ.	Max.	Unit
Static Electrical Characteristics @ T_c = 25°C (unless otherwise stated)						
V _{(BR)DSS}	Drain-Source Breakdown Voltage	V _{GS} =0V, I _D =250μA	60	--	--	V
I _{DSS}	Zero Gate Voltage Drain Current(T _c =25°C)	V _{DS} =60V, V _{GS} =0V	--	--	1	μA
	Zero Gate Voltage Drain Current(T _c =125°C)	V _{DS} =60V, V _{GS} =0V	--	--	100	μA
I _{GSS}	Gate-Body Leakage Current	V _{GS} =±20V, V _{DS} =0V	--	--	±100	nA
V _{GS(TH)}	Gate Threshold Voltage	V _{DS} =V _{GS} , I _D =250μA	1.0	2.0	3.0	V
R _{DS(ON)}	Drain-Source On-State Resistance ^②	V _{GS} =10V, I _D =8A	--	9.5	12	mΩ
R _{DS(ON)}	Drain-Source On-State Resistance ^②	V _{GS} =4.5V, I _D =4A	--	11.5	14	mΩ
Dynamic Electrical Characteristics @ T_c = 25°C (unless otherwise stated)						
R _g	Gate Resistance	V _{DS} =30V, V _{GS} =0V, f=1MHz	--	2.8	--	Ω
C _{iss}	Input Capacitance		--	1905	--	pF
C _{oss}	Output Capacitance		--	205	--	pF
C _{rss}	Reverse Transfer Capacitance		--	180	--	pF
Q _g	Total Gate Charge	V _{DS} =30V, I _D =10A, V _{GS} =10V	--	26	--	nC
Q _{gs}	Gate-Source Charge		--	6.5	--	nC
Q _{gd}	Gate-Drain Charge		--	4.5	--	nC
Switching Characteristics						
t _{d(on)}	Turn-on Delay Time	V _{DD} =30V, I _D =10A, R _G =6.8Ω, V _{GS} =10V	--	9	--	nS
t _r	Turn-on Rise Time		--	5	--	nS
t _{d(off)}	Turn-Off Delay Time		--	28	--	nS
t _f	Turn-Off Fall Time		--	4	--	nS
Source- Drain Diode Characteristics @ T_c = 25°C (unless otherwise stated)						
V _{SD}	Forward on voltage	I _{SD} =2A, V _{GS} =0V	--	0.71	1.2	V
t _{rr}	Reverse Recovery Time	T _j =25°C, I _{sd} =10A, V _{GS} =0V	--	23	--	nS
Q _{rr}	Reverse Recovery Charge	di/dt=100A/μs		52		nC

NOTE:

- ① Repetitive rating; pulse width limited by max. junction temperature.
 ② Pulse width ≤ 300μs; duty cycles ≤ 2%.

Typical Characteristics

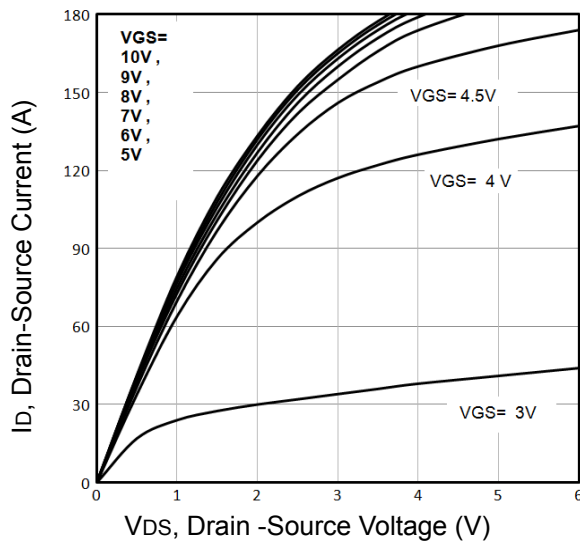

Fig1. Typical Output Characteristics

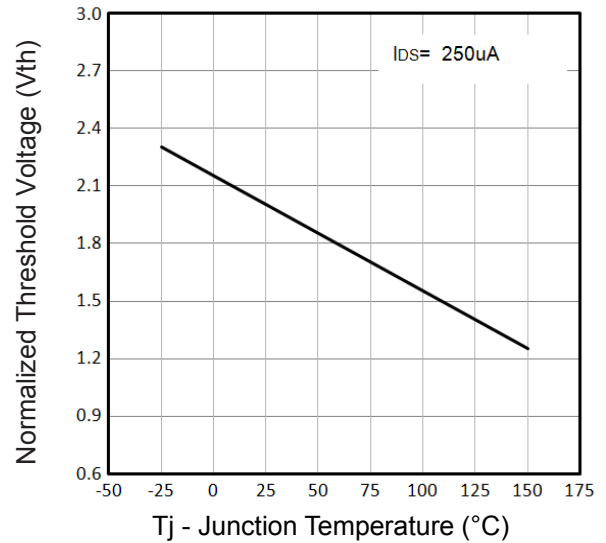

Fig2. Normalized Threshold Voltage Vs. Temperature

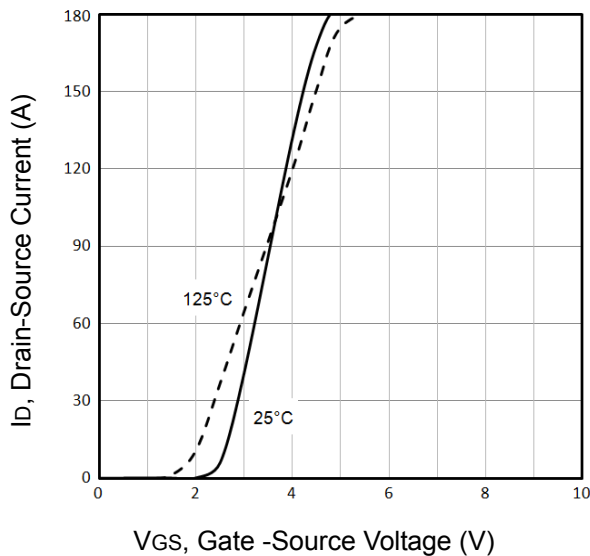

Fig3. Typical Transfer Characteristics

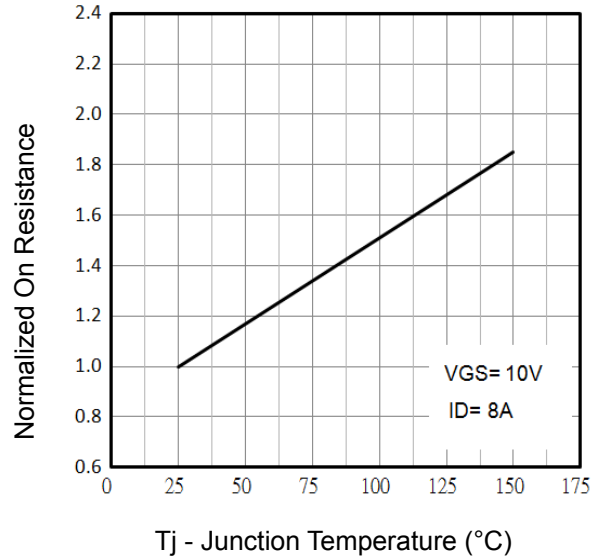

Fig4. Normalized On-Resistance Vs. Temperature

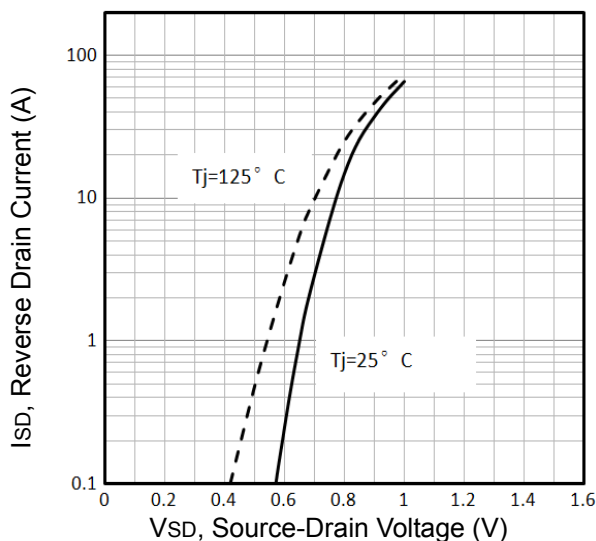

Fig5. Typical Source-Drain Diode Forward Voltage

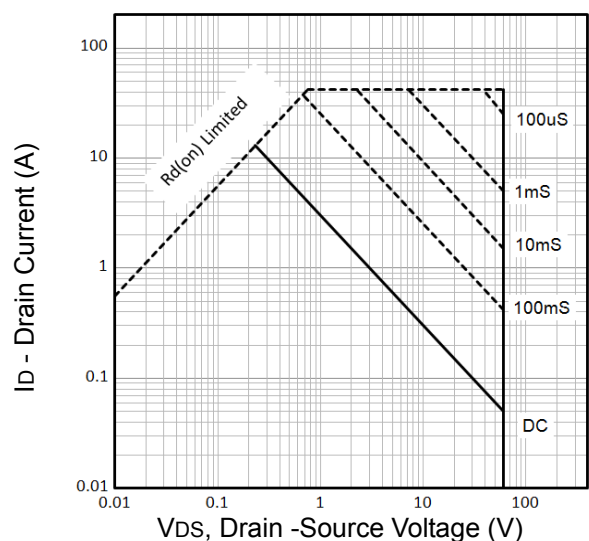

Fig6. Maximum Safe Operating Area

Typical Characteristics

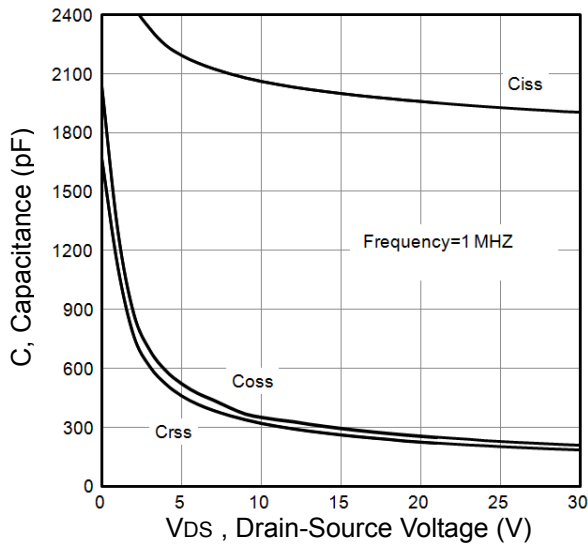

Fig7. Typical Capacitance Vs.Drain-Source Voltage

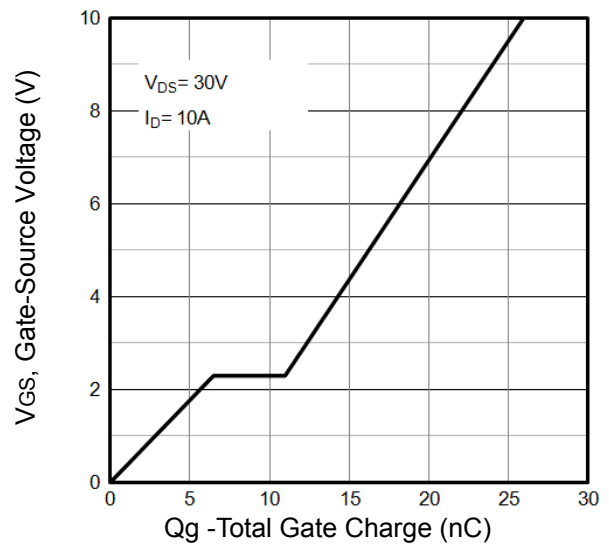

Fig8. Typical Gate Charge Vs.Gate-Source

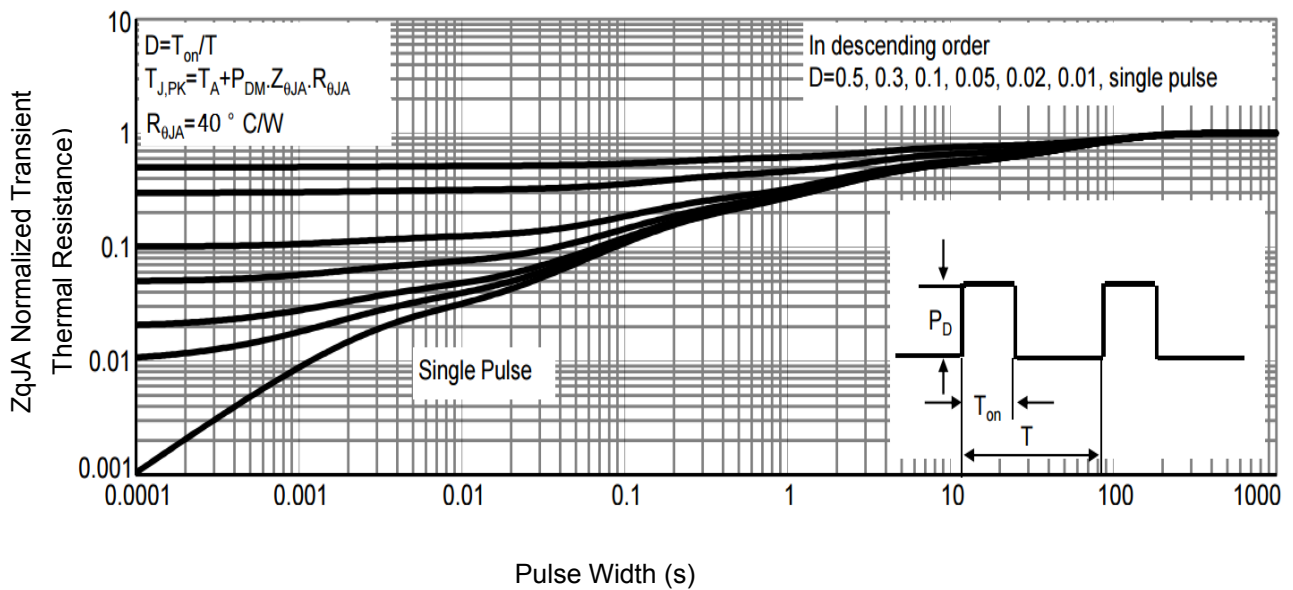

Fig9. Normalized Maximum Transient Thermal Impedance

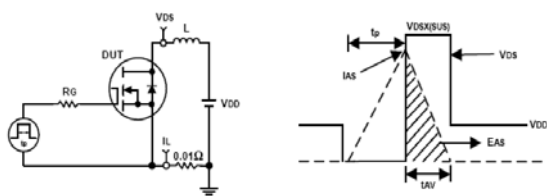

Fig10. Unclamped Inductive Test Circuit and waveforms

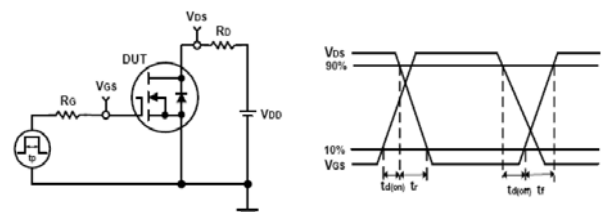
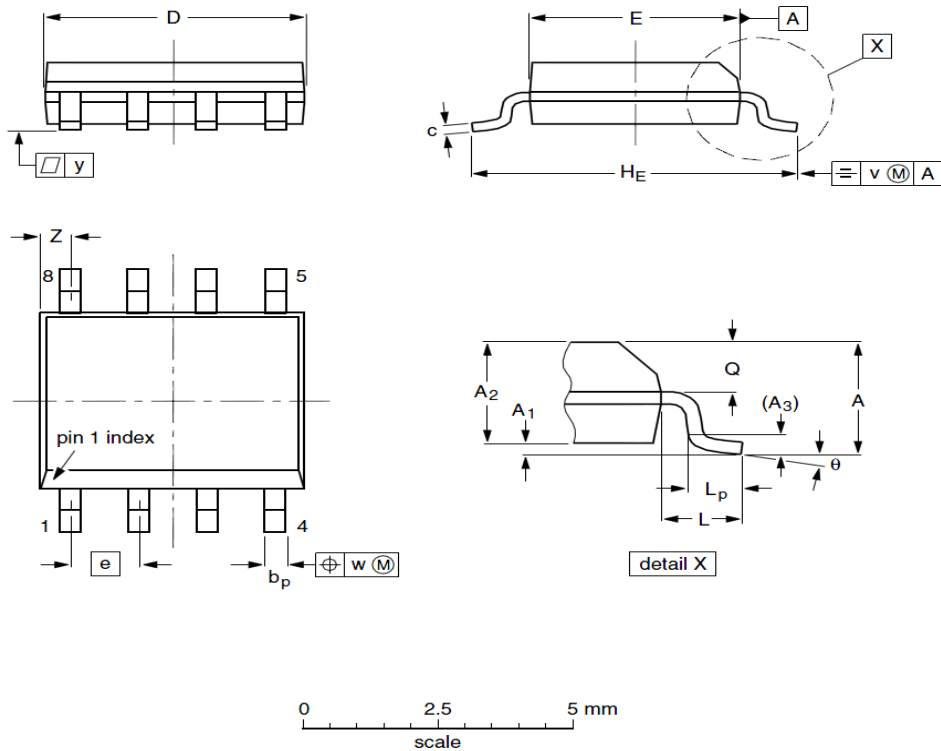

Fig11. Switching Time Test Circuit and waveforms

SOP8 Package Outline



DIMENSIONS (unit : mm)

Symbol	Min	Typ	Max	Symbol	Min	Typ	Max
A	--	1.75	--	A ₁	0.10	0.18	0.25
A ₂	1.25	1.35	1.45	A ₃	--	0.25	--
b _p	0.36	0.42	0.49	c	0.19	0.22	0.25
D	4.80	4.92	5.00	E	3.80	3.90	4.00
e	--	1.27	--	H _E	5.80	5.98	6.20
L	--	1.05	--	L _p	0.40	0.68	1.00
Q	0.60	0.65	0.70	v	--	0.25	--
w	--	0.25	--	y	--	0.10	--
Z	0.30	0.50	0.70	θ	0°		8°

Customer Service

Sales and Service:

sales@vgsemi.com

Vanguard Semiconductor CO., LTD

TEL: (86-755) -26902410

FAX: (86-755) -26907027

WEB: www.vgsemi.com