

## Features

- N-Channel, 5V Logic Level Control
- Enhancement mode
- Very low on-resistance  $R_{DS(on)}$  @  $V_{GS}=4.5\text{ V}$
- Fast Switching
- 100% Avalanche test
- Pb-free lead plating; RoHS compliant



Part ID	Package Type	Marking	Tape and reel information
VS3618AE	PDFN3333	3618AE	5000PCS/Reel

$V_{DS}$	30	V
$R_{DS(on),TYP} @ V_{GS}=10\text{ V}$	6	m $\Omega$
$R_{DS(on),TYP} @ V_{GS}=4.5\text{ V}$	9	m $\Omega$
$I_D$	50	A

PDFN3333

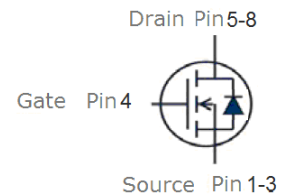

## Maximum ratings, at $T_A = 25^\circ\text{C}$ , unless otherwise specified

Symbol	Parameter	Rating	Unit
$V_{(BR)DSS}$	Drain-Source breakdown voltage	30	V
$I_S$	Diode continuous forward current	$T_C = 25^\circ\text{C}$	50 A
$I_D$	Continuous drain current @ $V_{GS}=10\text{V}$	$T_C = 25^\circ\text{C}$	50 A
		$T_C = 100^\circ\text{C}$	31 A
$I_{DM}$	Pulse drain current tested ①	$T_C = 25^\circ\text{C}$	200 A
EAS	Avalanche energy, single pulsed ②	25	mJ
$P_D$	Maximum power dissipation	$T_C = 25^\circ\text{C}$	30 W
$V_{GS}$	Gate-Source voltage	$\pm 20$	V
$T_{STG} T_J$	Storage and operating temperature range	-55 to 150	$^\circ\text{C}$

## Thermal Characteristics

Symbol	Parameter	Typical	Unit
$R_{\theta JC}$	Thermal Resistance-Junction to Case	4.1	$^\circ\text{C/W}$
$R_{\theta JA}$	Thermal Resistance Junction-Ambient	35	$^\circ\text{C/W}$



Symbol	Parameter	Condition	Min.	Typ.	Max.	Unit
<b>Static Electrical Characteristics @ T<sub>j</sub>=25°C (unless otherwise stated)</b>						
V <sub>(BR)DSS</sub>	Drain-Source Breakdown Voltage	V <sub>GS</sub> =0V I <sub>D</sub> =250μA	30	--	--	V
I <sub>DSS</sub>	Zero Gate Voltage Drain Current	V <sub>DS</sub> =30V, V <sub>GS</sub> =0V	--	--	0.1	μA
	Zero Gate Voltage Drain Current(T <sub>j</sub> =125°C)	V <sub>DS</sub> =30V, V <sub>GS</sub> =0V	--	--	100	μA
I <sub>GSS</sub>	Gate-Body Leakage Current	V <sub>GS</sub> =±20V, V <sub>DS</sub> =0V	--	--	±100	nA
V <sub>GS(TH)</sub>	Gate Threshold Voltage	V <sub>DS</sub> =V <sub>GS</sub> , I <sub>D</sub> =250μA	1.0	1.8	2.5	V
R <sub>DS(ON)</sub>	Drain-Source On-State Resistance <sup>③</sup>	V <sub>GS</sub> =10V, I <sub>D</sub> =15A	--	6	7	mΩ
R <sub>DS(ON)</sub>	Drain-Source On-State Resistance <sup>③</sup>	V <sub>GS</sub> =4.5V, I <sub>D</sub> =10A	--	9	11	mΩ
<b>Dynamic Electrical Characteristics @ T<sub>j</sub> = 25°C (unless otherwise stated)</b>						
C <sub>iss</sub>	Input Capacitance	V <sub>DS</sub> =15V, V <sub>GS</sub> =0V, f=1MHz	--	1110	--	pF
C <sub>oss</sub>	Output Capacitance		--	180	--	pF
C <sub>rss</sub>	Reverse Transfer Capacitance		--	130	--	pF
R <sub>g</sub>	Gate Resistance	f=1MHz	--	1.9	--	Ω
Q <sub>g</sub>	Total Gate Charge	V <sub>DS</sub> =15V, I <sub>D</sub> =15A, V <sub>GS</sub> =10V	--	23	--	nC
Q <sub>gs</sub>	Gate-Source Charge		--	6.2	--	nC
Q <sub>gd</sub>	Gate-Drain Charge		--	8.9	--	nC
<b>Switching Characteristics</b>						
t <sub>d(on)</sub>	Turn-on Delay Time	V <sub>DD</sub> =15V, I <sub>D</sub> =15A, R <sub>G</sub> =6.8Ω, V <sub>GS</sub> =10V	--	14	--	nS
t <sub>r</sub>	Turn-on Rise Time		--	27	--	nS
t <sub>d(off)</sub>	Turn-Off Delay Time		--	65	--	nS
t <sub>f</sub>	Turn-Off Fall Time		--	19	--	nS
<b>Source- Drain Diode Characteristics @ T<sub>j</sub> = 25°C (unless otherwise stated)</b>						
V <sub>SD</sub>	Forward on voltage	I <sub>SD</sub> =15A, V <sub>GS</sub> =0V	--	0.84	1.2	V
t <sub>rr</sub>	Reverse Recovery Time	T <sub>j</sub> =25°C, I <sub>sd</sub> =15A, V <sub>GS</sub> =0V di/dt=100A/μs	--	31	--	nS
Q <sub>rr</sub>	Reverse Recovery Charge		--	95	--	nC

NOTE:

- ① Repetitive rating; pulse width limited by max. junction temperature.
- ② Limited by T<sub>jmax</sub>, starting T<sub>j</sub> = 25°C, L = 0.5mH, R<sub>G</sub> = 25Ω, I<sub>AS</sub> = 10A, V<sub>GS</sub>=10V. Part not recommended for use above this value
- ③ Pulse width ≤ 300μs; duty cycle ≤ 2%.

Typical Characteristics

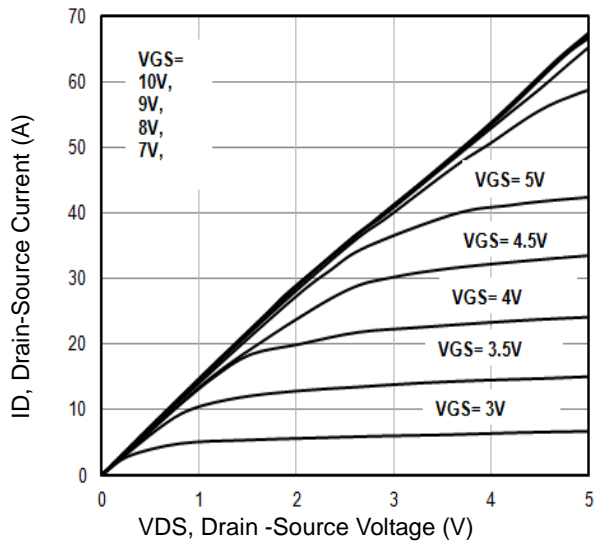

Fig1. Typical Output Characteristics

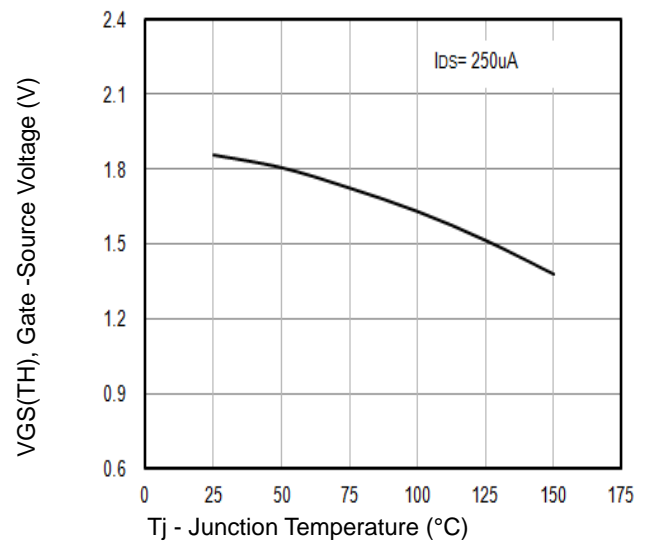

Fig2.  $V_{GS(TH)}$  Gate-Source Voltage Vs.  $T_j$

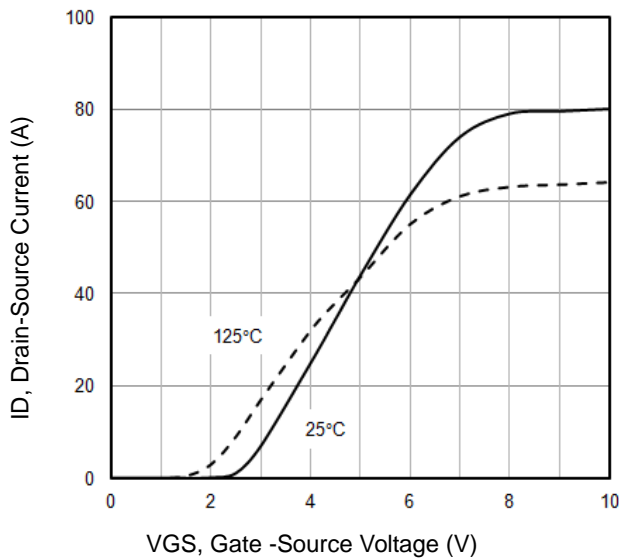

Fig3. Typical Transfer Characteristics

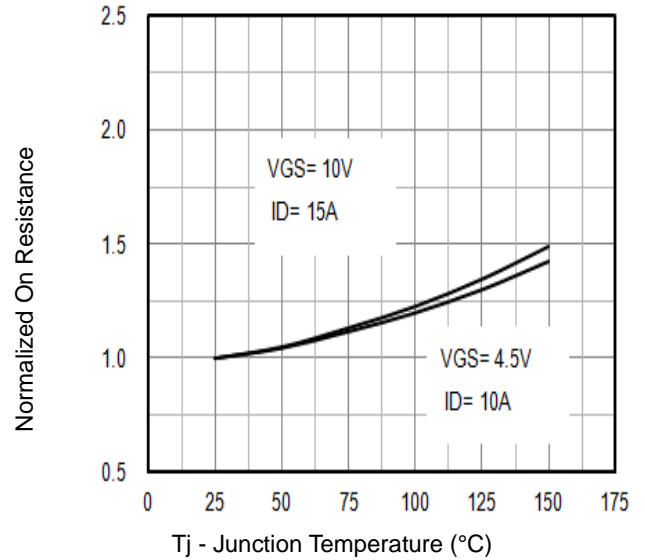

Fig4. Normalized On-Resistance Vs.  $T_j$

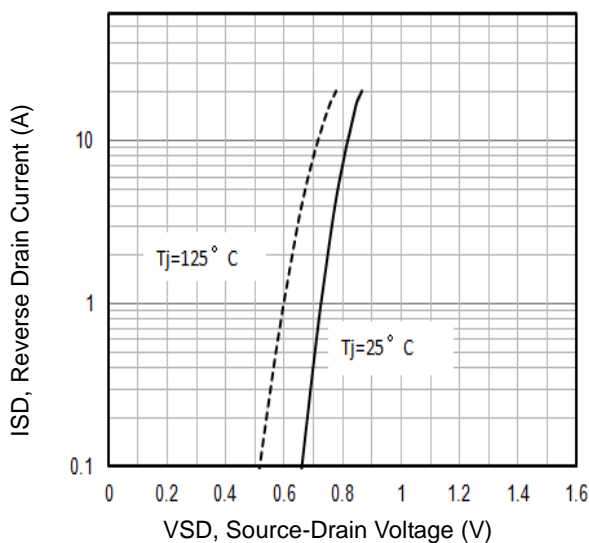

Fig5. Typical Source-Drain Diode Forward Voltage

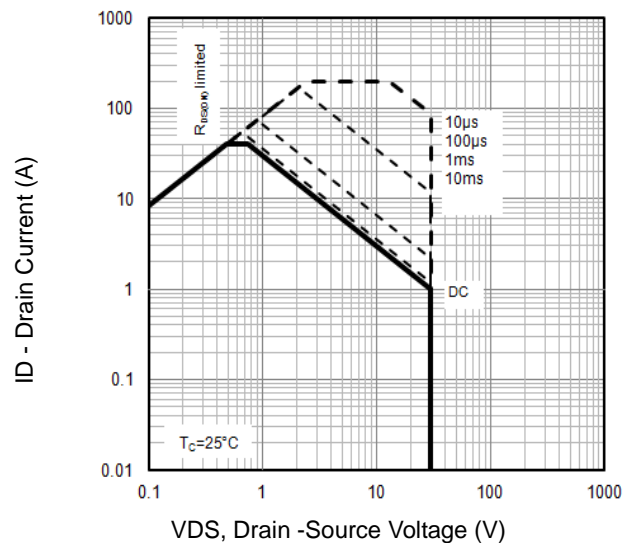

Fig6. Maximum Safe Operating Area

Typical Characteristics

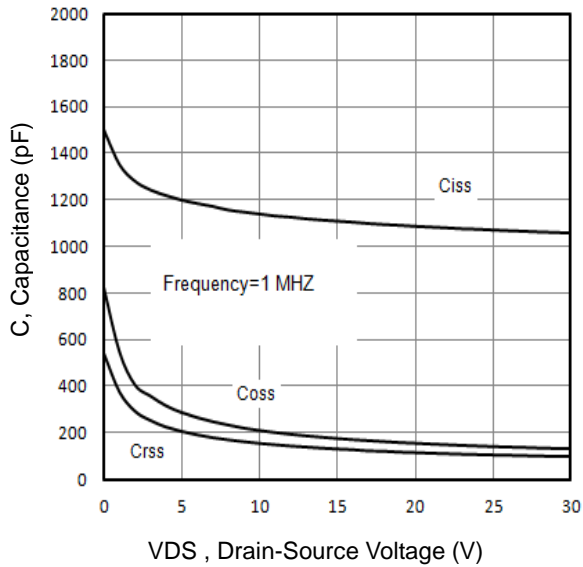

Fig7. Typical Capacitance Vs.Drain-Source Voltage

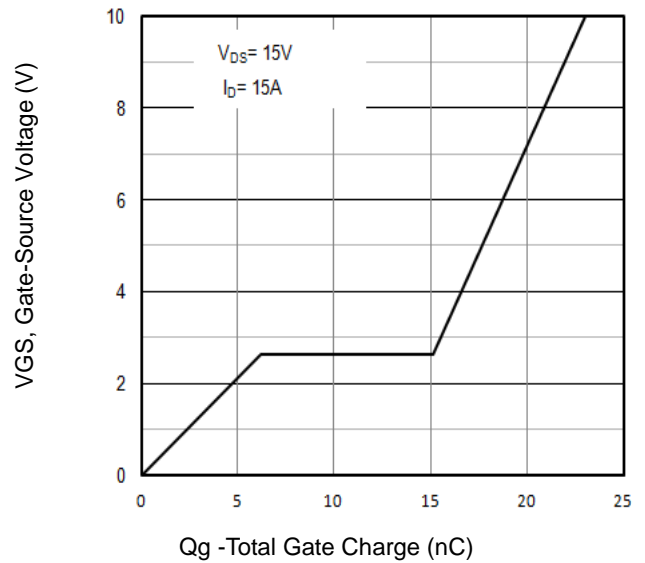

Fig8. Typical Gate Charge Vs.Gate-Source Voltage

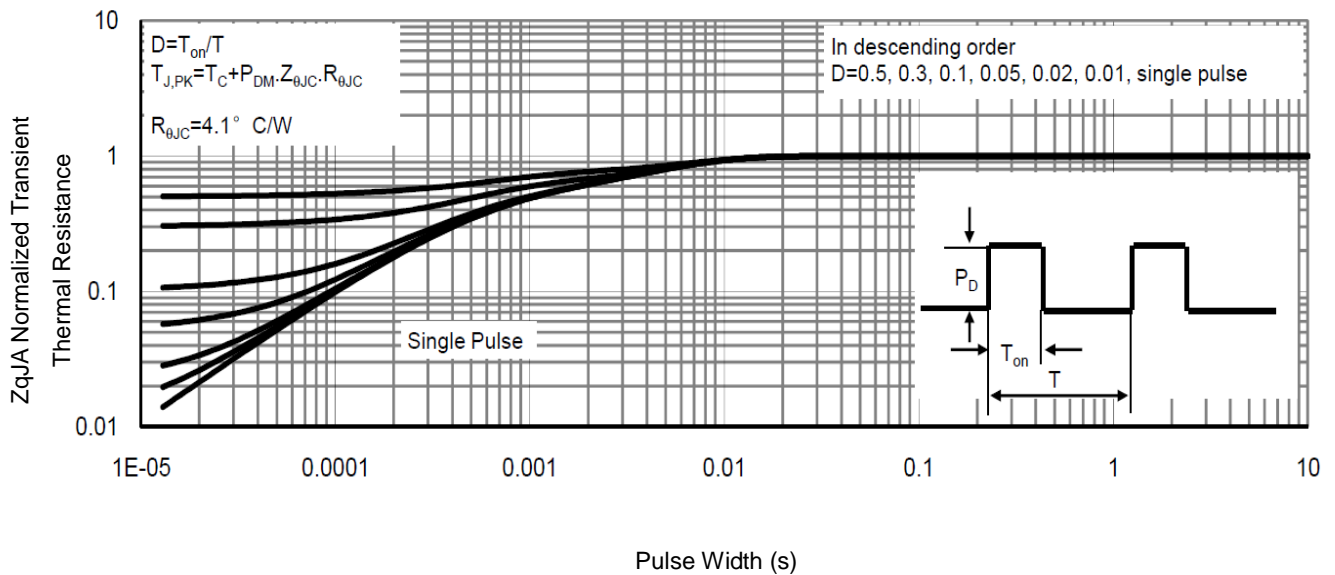

Fig9. Normalized Maximum Transient Thermal Impedance

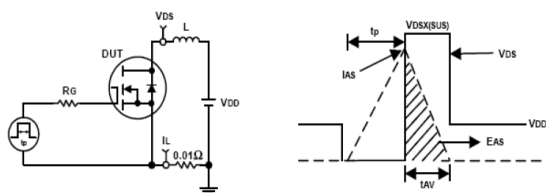

Fig10. Unclamped Inductive Test Circuit and waveforms

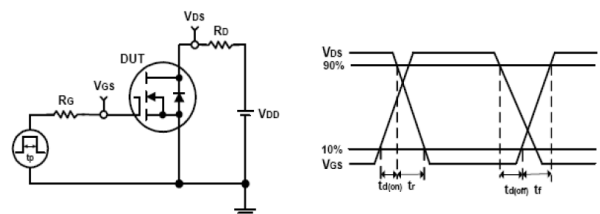
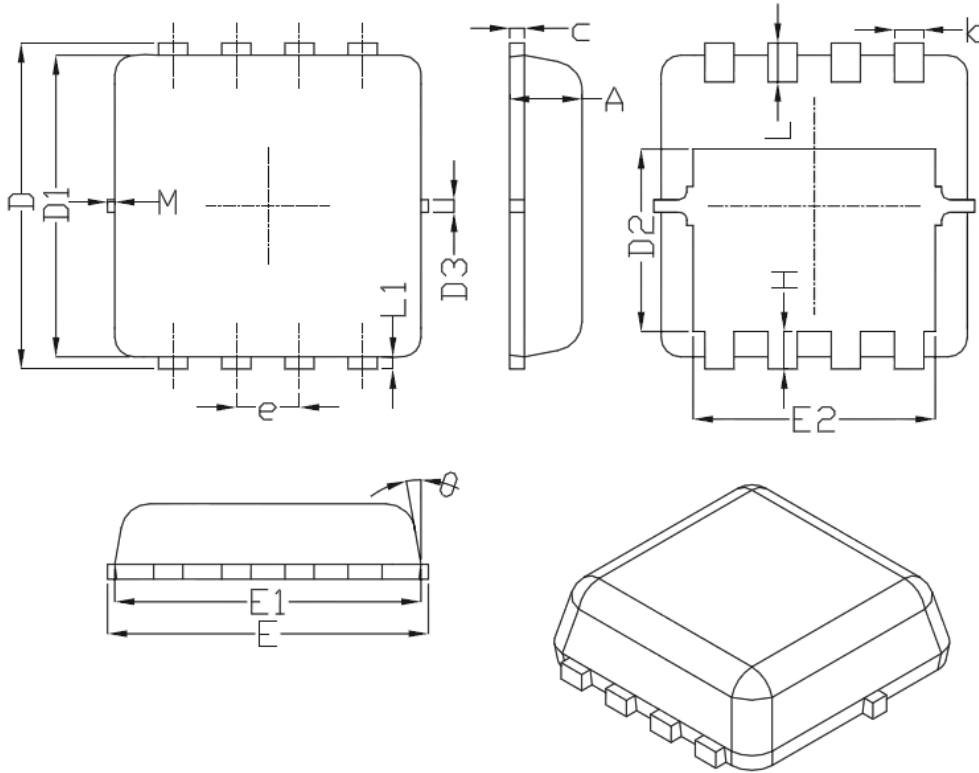

Fig11. Switching Time Test Circuit and waveforms

PDFN3333 Package Outline Data



**DIMENSIONS** ( unit : mm )

Symbol	Min	Typ	Max	Symbol	Min	Typ	Max
A	0.70	0.75	0.80	b	0.25	0.30	0.35
C	0.10	0.15	0.25	D	3.25	3.35	3.45
D1	3.00	3.10	3.20	D2	1.78	1.88	1.98
D3	--	0.13	--	E	3.20	3.30	3.40
E1	3.00	3.15	3.20	E2	2.39	2.49	2.59
e	0.65BSC			H	0.30	0.39	0.50
L	0.30	0.40	0.50	L1	--	0.13	--
θ	--	10°	12°	M	*	*	0.15

\*Not specified

## Customer Service

**Sales and Service:**

[sales@vgsemi.com](mailto:sales@vgsemi.com)

**Vanguard Semiconductor CO., LTD**

**TEL:** (86-755) -26902410

**FAX:** (86-755) -26907027

**WEB:** [www.vgsemi.com](http://www.vgsemi.com)